

**OPERATING AND INSTALLATION MANUAL**

**CONVERTER**

**ML 51**

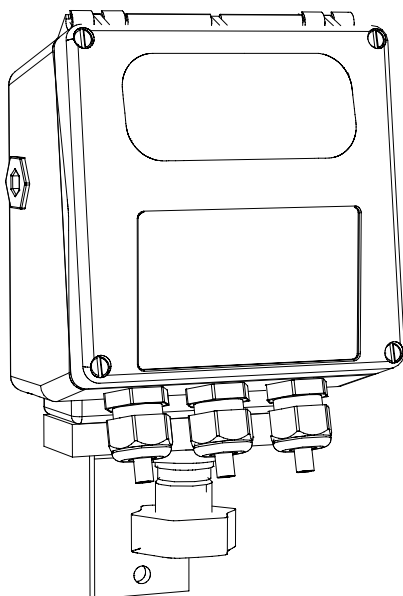

## INDEX

<b>INTRODUCTION</b>	<b>3</b>
<b>SYMBOLS USED IN THE MANUAL</b>	<b>3</b>
<b>TECHNICAL CHARACTERISTICS</b>	<b>4</b>
<b>OVERALL DIMENSION</b>	<b>5</b>
<b>INTERNAL VIEW OF CONVERTER</b>	<b>7</b>
<b>INPUT/OUTPUT</b>	<b>8</b>
<b>VISUALIZATION PAGE ( WITH IF21 )</b>	<b>10</b>
<b>FLAGS INTERPRETATION AND LED</b>	<b>11</b>
<b>FUNCTIONS</b>	<b>13</b>
<b>ACCESS TO THE CONFIGURATION MENU</b>	<b>15</b>
<b>FUNCTIONS DESCRIPTION</b>	<b>17</b>
<b>ALARM MESSAGES, CAUSES AND ACTIONS TO BE TAKEN</b>	<b>22</b>
<b>ANOMALIES CODES</b>	<b>22</b>

## INTRODUCTION

This manual is integral part of the product. Read carefully the instructions contained since they give important indications for the safe use and maintenance.

Technical information and relative products in this manual could undergo modifications without any previous notice.

The flow meter must be used for what it has been built for. The improper use, possible tampering of the instrument or parts of it and substitutions of any not original components, make the warranty to decay automatically.

The manufacturer is considered responsible only if the instrument it's used in his original configuration.

Reproduction of the present manual and of any possible software supplied with the instrument is strictly forbidden.

### Symbols Used in the manual



ATTENTION



DANGER ELECTRIC SHOCK



WARNING



PRECAUTIONS

## TECHNICAL CHARACTERISTICS



### ELECTRIC CHARACTERISTICS

**Classification of the instrument:** class I, IP 67, category of installation II

Power supply versions	Power supply voltage	Power supply frequency	current max
Loop 4/20	18÷36 Vdc	//	24 mA
4/20 disable	12 Vdc+/-10%	CONSUMPTION 12 mA	



### ENVIRONMENTAL CONDITIONS OF USE

1. The instrument can be installed inside or outside buildings
2. Altitude: from -200 a 6000 m (from -656 to 19685 feet)
3. Humidity range: 0÷100% (IP 65)

Line voltage range: (see table on technical characteristics)



### OPERATING TEMPERATURE

CONVERTER			
Ambient Temp.			
Min.		Max	
°C	°F	°C	°F
-20*	-4*	50	140



\* For discontinuous use, the installation of a heating resistance is necessary

## OVERALL DIMENSION

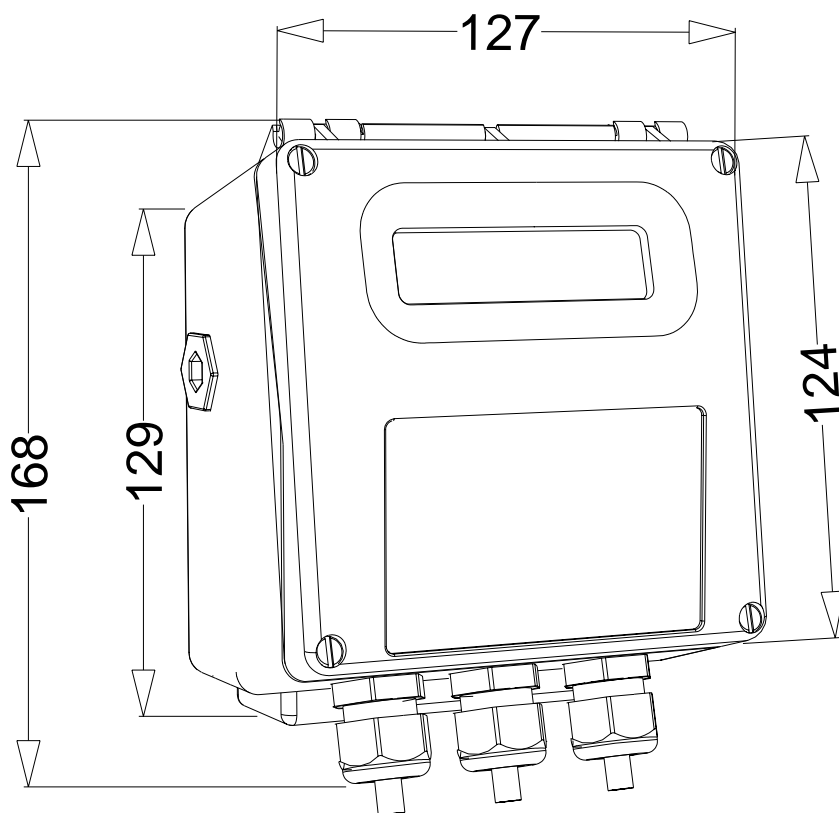



## GROUNDING INSTRUCTIONS

For the correct operation of the meter it's **NECESSARY** that sensor and liquid are equipotential, so **ALWAYS** connect **sensor** and **converter** to the ground



## INPUT/OUTPUT ISOLATION

1. Input/output are insulated up to 500V



## CONVERTER POWER SUPPLY

Power supply

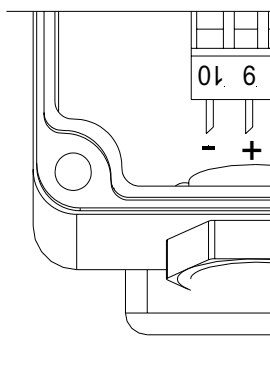

- ❑ Before connecting the power supply, verify that the mains voltage falls between the limits indicated on the tag plate
- ❑ **ATTENTION:** the converters on dc power supply line are not protected against the inversions of polarity.
- ❑ For the wiring use only approved conductors, with fireproof properties.
- ❑ In the proximity of the instrument Provide a circuit breaker that must be easily accessible from the operator and clearly identified.

**NOTE:** characteristics of meter's power supply, see page 4

### INTERNAL VIEW OF CONVERTER

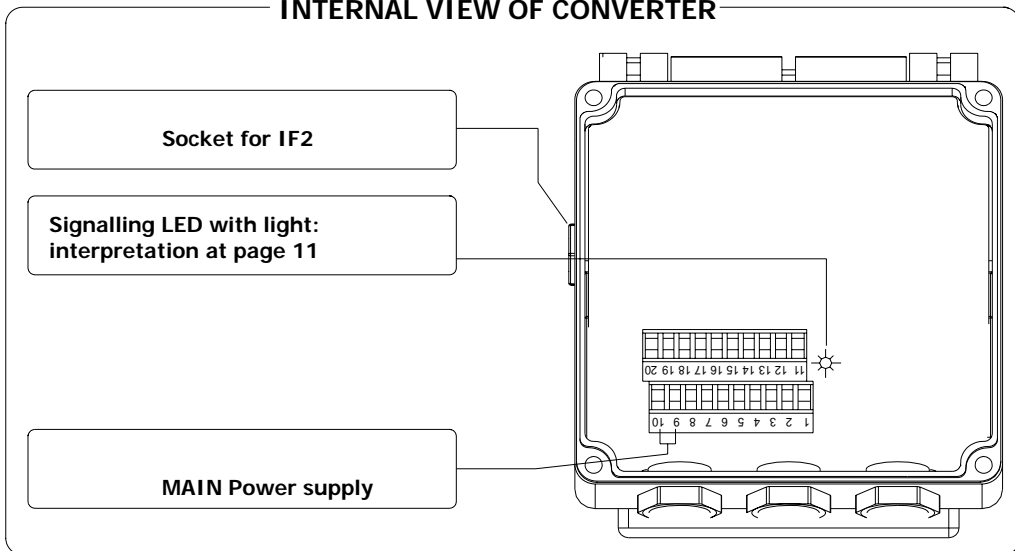

### TERMINAL BLOCKS OF CONVERTER

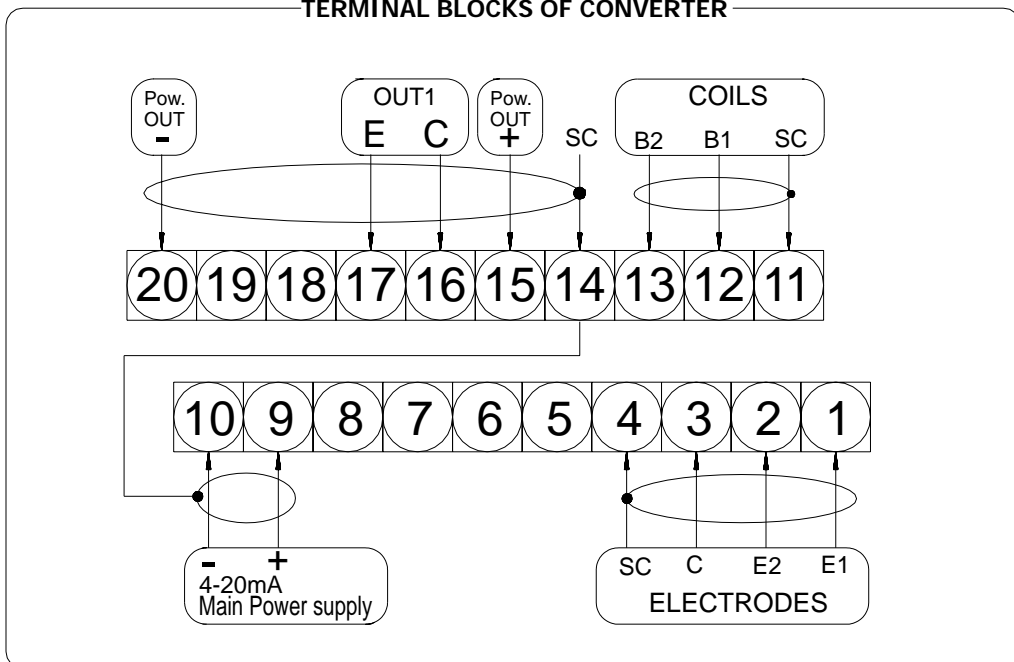

## INPUT/OUTPUT

### ON/OFF OUT

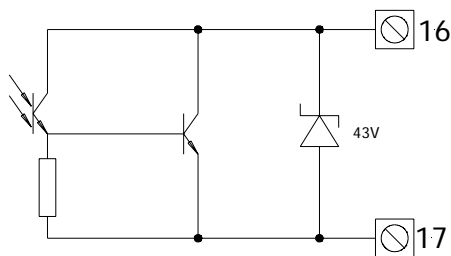

- Opto-insulated output with collector and emitter terminals floating and freely connectable
- Maximum switching voltage: 40 Vdc
- Maximum switching current: 10mA
- Maximum saturation voltage between collector and emitter @100mA: 1,2V
- Maximum switching frequency 32 Hz
- Maximum reverse current bearable on the input during and accidental polarity reversion (VEC): 100mA
- Insulation from other secondary circuits: 500 Vdc

### Power supply/Out 4 ÷ 20mA

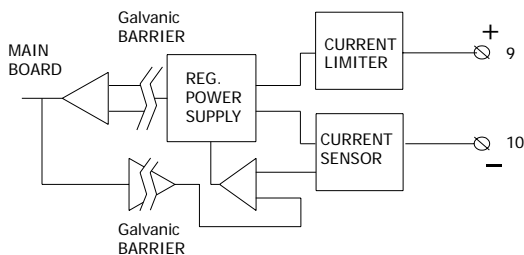

- Working voltage : 18 ÷ 36 Vdc

MAX LOAD TABLE	
Power Supply	R_MAX (ohm)
21.6 (24V-10%)	300
24	400
26.4 (24V+10%)	500
30	680
36	950

This option allows using the converter like transmitter with technique " 2 wire": the current 4/20 beyond to give the measure also SUPPLY the converter . The MINIMUM value of current, correspondent to "0" FLOW RATE is 4 mA .

## START UP AND MAINTENANCE OF THE INSTRUMENTS

Before starting up the instrument please verify the following:

- ❑ Power supply voltage must correspond to that specified in the name plate
- ❑ Electric connections must be done as described at page 7
- ❑ Ground connections must be done

Verify periodically:

- ❑ The integrity of the power supply cables, wiring and other electrical parts connected
- ❑ The integrity of the instrument's housing (this must not have bruises or other damages that may compromise the hermetical sealing)
- ❑ The tightening of the sealing elements (cable glands, covers, etc.)
- ❑ The mechanical fixing of the instrument on the pipe or on the wall stand

# VISUALIZATION PAGE ( WITH IF21 )



Scale

Flow rate visualization

dm<sup>3</sup>/s +0.000 1  
+0.0%-----

\*Direct totalizer  
\*Reverse totalizer

I+dm<sup>3</sup> 61.456  
P+dm<sup>3</sup> 61.456



Push to change visualisation

**FUNZIONE DI "VALUTA" ATTIVA**

Flow rate visualization

dm<sup>3</sup>/s +0.000 1  
P+dm<sup>3</sup> 61.456

Flow rate visualization

dm<sup>3</sup>/s +0.000 1  
m/s 0.00-----

\*Partial direct/reverse totalizer



Push to change visualisation

Speed of fluid

Alternate page  
( 4sec. per pagina )

===== >  
< =====



Push to see alarms page

Alarms

MISURA>FS

\* The maximum digit shown from the totalizer is 999999999 independently from the number of selected decimal. Beyond this value the totalizer are reset.

## Flags interpretation and LED

FLAGS

dm<sup>3</sup>/s +0.00005!M  
+0.00%\_ \_ \_ \_ \_

INTERPRETATION FLAGS	
FLAG	DESCRIPTION
M	Alarm max activated
m	Alarm min activated
!	- Interruption coils circuit - Segnal error - Empty pipe
C	Calibration running
S	Simulation

### LED INTERPRETATION

PERMANENT LIGHT: initialisation
FLASHING at 10/20 Hz : normal function
FLASHING at around 1 second : alarm on

## ACCESS CODE

Some functions in the converter are enabled by the access codes. The information of this manual is related to all the functions available with L2 level. All the functions available through higher level are protected and reserved to the service.

### Description of the L2 access code

(menu "11 Internal data" pos. 11.1)

- with code L2 = 00000** (with this code only) you disable the request of code L2  
NOTE: the availability of the functions is related to the selected block
- \*with L2 customised** (freely chosen by the user) you can proceed programming all the functions up to L2 security level, entering its code whenever you enter the Main menu

**\*ATTENTION:** take note very carefully of the customised code you have chosen, since there is no way for the user to retrieve it if it is forgotten

## FACTORY PRESETTINGS

The converter is delivered with access code L2:

11111

and with the "Quick start menu" enable. Press the key  to access to the "Quick start menu" from one of the visualization pages

0-QUICK START  
F=1=dm<sup>3</sup>/s 05.000

The "Quick start menu" may be set without entering any access code (see example 1 on page 14).

## KEYBOARD

**SHORT PRESSING (< 1 SECOND):**

It increases the numeric figure or the parameter selected by the cursor  
It goes to the previous subject on the menu  
batch start/stop (when enabled)

**LONG PRESSING (> 1 SECOND):**

It decreases the numeric figure or the parameter selected by the cursor  
It goes to the next subject on the menu

**SHORT PRESSING (< 1 SECOND):**

It moves the cursor rightwards on the input field  
It goes to the following subject of the menu  
It changes the display of the process data

**LONG PRESSING (> 1 SECOND):**

It moves the cursor leftwards on the input field  
It goes to the previous subject on the menu

**SHORT PRESSING (< 1 SECOND):**

It enters/leaves the selected function  
It enables the main menu for the instrument configuration  
It cancels the selected function under progress

**LONG PRESSING (> 1 SECOND):**

It leaves the current menu  
It enables the totalise reset request (when enabled)  
It confirms the selected function

## BLIND CONVERTERS

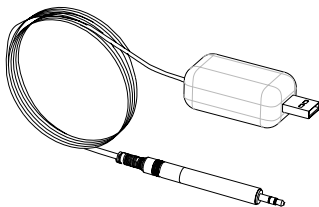

For converter without keyboard (blind version), the programming of functions is made up by IF2 serial device:

## Functions

(for detail functions with symbol "\*" see the manual from page 16)

### MAIN MENU 1-Sensor

```

1-SENSOR
ND=mm      00025
KA=        +01.0000
Sens.type= 00
Ins.position= 0
KL=[0]    +00.0000
KL=[0]    +00.0000
E.P.detect= OFF
E.P.calibr.
Autozero cal.
Autozero res.
  
```

- 1.1 Insert ND of sensor (0-3000)
- 1.2 Calibration data of sensor visualized on sensor's label
- 1.3 Type of sensor: Enter the first two characters of the serial number of the sensor
- 1.4 Position for insertion sensors: 0=1/8DN, 1=1/2DN, 2=7/8DN
- 1.5 Factory parameter
- 1.6 Enables the empty pipe detection feature
- 1.7\* Enables the automatic calibration procedure of the empty pipe detection
- 1.8\* Enables the automatic zero calibration system
- 1.9 Reset the preceding function

### MAIN MENU 2-Scales

```

2-SCALES
Fs1=dm³/s 05.000
Fs2=dm³/s 05.000
Tot.MU=dm³ 1.000
Pls =dm³   01.0000
Tpls =ms   0050.00
  
```

- 2.1\* Full scale 1 value
- 2.2\* Full scale 2 value
- 2.3\* Unit of measure and number of decimal totalizes
- 2.4\* Pulse value
- 2.5\* Duration of the pulse

### MAIN MENU 3-Measure

```

3-MEASURE
Tconst=s 0002.0
Skip thr=% 025
Peak thr=% 125
Cut-off=% 07.0
Autocal.= OFF
Autorange= OFF
  
```

- 3.1\* Time constant
- 3.2\* Acceleration threshold
- 3.3\* Anomalous signal pick cut off threshold
- 3.4 Low flow zero threshold: 0-25% of full scale value
- 3.5 Enable every hour an internal cycle of calibration. The measure it's stopped for 8-15 sec.
- 3.6 Automatic change of scale

### MAIN MENU 4-Alarms

```

4-ALARMS
Max thr+=% 000
Max thr-=% 000
Min thr+=% 000
Min thr-=% 000
Hyst.=%    03
E.p.thr.= 075
mA v.fault=% 113
  
```

- 4.1 Maximum value alarm set for direct flow rate
- 4.2 Maximum value alarm set for reverse flow rate
- 4.3 Minimum value alarm set for direct flow rate
- 4.4 Minimum value alarm set for reverse flow rate
- 4.5 Hysteresis threshold set for the minimum and maximum flow rate alarms
- 4.6 Empty pipe detection threshold. It's automatically set by the function 1.9
- 4.7\* Current output value in case of failure

## MAIN MENU 5-Inputs

```
5-INPUTS
T+ reset= OFF
P+ reset= OFF
T- reset= OFF
P- reset= OFF
Count lock= OFF
Calibration= OFF
Range change= ON
```

- 5.1\* Total direct (positive) flow totalise reset enable
- 5.2\* Partial direct (positive) flow totalise reset enable
- 5.3\* Total reverse (negative) flow totalise reset enable
- 5.4\* Partial reverse (negative) flow totalise reset enable
- 5.5 Totalise counting lock command (see page 12)
- 5.6\* Autozero calibration external command
- 5.7 Range change external command (see function 3.4)

## MAIN MENU 6-Outputs

```
6-OUTPUTS
Out1= OFF
Out mA= ON
Out mA=4_22
```

- 6.1\* Output functions
- 6.2 Enable 4÷20 output
- 6.3\* Field for 4/20 mA out

## MAIN MENU 7-Communication

```
7-COMMUNICATION
IF2 prot.= DPP
IF2 supply= OFF
```

- 7.1 Choice of the communication protocol for the IF2 device
- 7.2 Only for factory use

## MAIN MENU 8-Display

```
8-DISPLAY
Language= EN
T+ reset
P+ reset
T- reset
P- reset
Quick start= OFF
Net total.= OFF
Currency= ON
Curr.decim.= 2
EUR/dm³+ 01.0000
EUR/dm³- 01.0000
```

- 8.1 Choice of the language: E= English, I=italian, F= French, S= Spanish
- 8.2\* Total direct (positive) flow totalise reset
- 8.3\* Partial direct (positive) flow totalise reset
- 8.4\* Total reverse (negative) flow totalise reset
- 8.5\* Partial reverse (negative) flow totalise reset
- 8.6 Quick start menu visualization
- 8.7 Enable the page of net totalizer (difference between direct and reverse. see page 11)
- 8.8 Visualizes the values of the partial totalise in the unit of selected currency
- 8.9 Choice of the numbers of decimals for the visualization currency value: From 0 to 3
- 8.10\*Value of conversion/currency for direct totalizer
- 8.11\*Value of conversion/currency for reverse totalizer

## MAIN MENU 10-Diagnostic

```
10-DIAGNOSTIC
Calibration
Self test
Simulation= OFF
```

- 10.1\* Enable the calibration of the converter
- 10.2\* Converter autotest
- 10.3\* Flow rate simulation enabling

## MENU PRINCIPALE 11-Dati interni

```
11-INTERNAL DATA
L2 keycode=00000
Load fact.pres.
Load user pres.
Save user pres.
Hours= 000031
KS= +1.0000
```

- 11.1 Level 2 access code enter
- 11.2 Load factory data pre-set
- 11.3 Load user data saved
- 11.4 Save user data
- 11.5 Visualisation of the total operation hours of the converter (function not editable)
- 11.7 Ks Coefficient

## ACCESS TO THE CONFIGURATION MENU

The access to the configuration menu can take place in two different modes:

- ❑ Through the **"Quick start menu"** where is possible to access directly to some of the principal functions
- ❑ Through the **"Main menu"** where is possible to access to all function with access code  $\leq 2$

Below are brought some examples relating to the change of the value in the function "2.1 Fs1"

### EXAMPLE: modifying the full scale value from $4\text{dm}^3/\text{s}$ to $5\text{dm}^3/\text{s}$ . from "Quick start menu"

1  $\text{dm}^3/\text{s}$  +0.416 \*1  
P+d<sub>m</sub> 124129.089



Enter in the "Quick start menu"

2 0-QUICK START  
Fs1= $\text{dm}^3/\text{s}$  04.000



Access to the function "Fs1"

3 0-QUICK START  
Fs1: $\text{dm}^3/\text{s}$  04.000



Push repeatedly

4 0-QUICK START  
Fs1: $\text{dm}^3/\text{s}$  04.000



Change the value

5 0-QUICK START  
Fs1= $\text{dm}^3/\text{s}$  05.000



Confirm the new value

6 0-QUICK START  
Fs1= $\text{dm}^3/\text{s}$  05.000



Long push

7  $\text{dm}^3/\text{s}$  +0.416 \*1  
P+d<sub>m</sub> 124129.089

Main page

**EXAMPLE: modifying the full scale value from 4dm<sup>3</sup>/s to 5dm<sup>3</sup>/s.  
from "Main Menu" (quick start menu enable)**

1 dm<sup>3</sup>/s +0.416 \*1  
P+dm<sup>3</sup>/s 124129.089



Enter in the "Quick start menu"

2 0-QUICK START  
Fs1=dm<sup>3</sup>/s 04.000



X 3 TIMES

3 0-QUICK START  
Main menu



Access to the "Main Menu"

4 0-QUICK START  
keycode L2:00000



X 5 TIMES

5 0-QUICK START  
keycode L2:11111



6 MAIN MENU  
1-Sensor



7 MAIN MENU  
2-Scales



Access to the "Scale" menu

8 2-SCALES  
Fs1=dm<sup>3</sup>/s 04.000



Access to the function "Fs1"

9 2-SCALES  
Fs1:dm<sup>3</sup>/s 04.000



Push repeatedly

10 2-SCALES  
Fs1:dm<sup>3</sup>/s 04.000



Change the value

11 2-SCALES  
Fs1:dm<sup>3</sup>/s 05.000



Confirm the new value

12 2-SCALES  
Fs1:dm<sup>3</sup>/s 05.000



Long push

13 MAIN MENU  
2-Scales



Long push

1 dm<sup>3</sup>/s +0.416 \*1  
P+dm<sup>3</sup>/s 124129.089

Main page

## FUNCTIONS DESCRIPTION

(description of the functions with access code < 3)

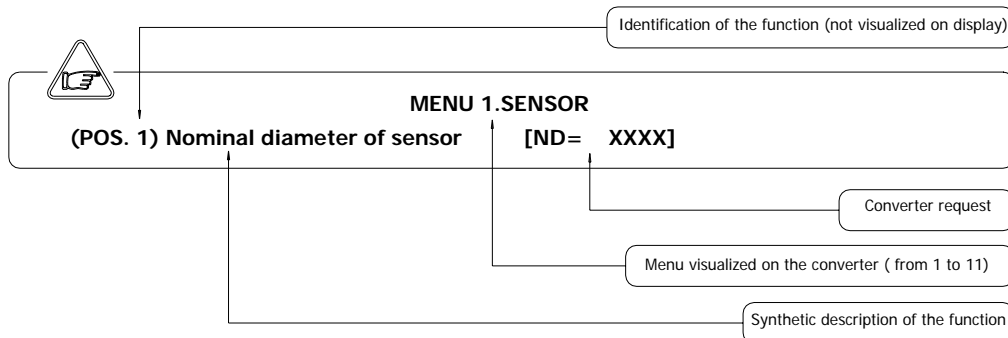

**N.B.:** follow are detailed description only some functions of the converter  
(see note to page 12)

### MENU 1.SENSOR

#### (POS. 1.7) "Empty pipe" calibration

[E.P. CALIBR.]

This function enables the automatic calibration procedure of the empty pipe detection function. Before performing this function, the sensor has to be completely filled with the liquid. The sensor has then to be emptied again and then you should press the key : the operation will have to be confirmed by pressing the key or any other key annul the operation. By this function the system sets the value of a parameter, which could also be manually changed (see function "E.P.thr" menu 4-ALARMS).

#### (POS. 1.8) "Autozero" calibration

[AUTOZERO CAL.]

Enables the automatic zero calibration system. To perform the sensor it is absolutely necessary the sensor is full of liquid and that the liquid is perfectly staying still. Even very small movement of the liquid may affect the result of this function. When the percentage flow rate value is stable press the key . Check the percentage flow rate value goes to zero, otherwise repeat the operation again. When the value is stable at zero, then press .

### MENU 2.SCALES

#### (POS. 2.1-2.2) Full scale n° 1-2

[FS1-2= dm<sup>3</sup>/S X.XXXX]

Full scale value set for range N.1-2. There are four fields to fill in order to set this parameter, from left to right: 1) volume unit of measure, 2) type of unit, 3) time unit of measure and 4) numeric value. The selection is made by positioning the cursor on the field to modify. To change the type of unit of measure (metric, British or American, mass or volume) the cursor has to be positioned on the symbol "/" (field N. 2). When the nominal diameter is set to zero it is possible to modify only the numeric field, since the unit of measure stays at m/sec. The following tables show the units of measure available and the conversion factor by comparison with 1 dm<sup>3</sup> and 1 kg. The converter accepts any kind of combination of units of measure satisfying both the following conditions:

- Numeric field value  $\leq 99999$
- $\frac{1}{25} f_{s_{max}} \leq \text{numeric field value} \leq f_{s_{max}}$ .

where  $f_{s_{max}}$  is the maximum full scale value corresponding to the sensor, equal to a 10 m/sec liquid speed. The units of measure are shown as appear on the display. The British and American units are diversified by using capital and small characters.

## Available units of mass and volume

<b>cm<sup>3</sup></b>	Cubic centimetre
<b>ml</b>	Millilitre
<b>l</b>	Litre
<b>dm<sup>3</sup></b>	Cubic decimetre
<b>dal</b>	Decalitre
<b>hl</b>	Hectolitre
<b>m<sup>3</sup></b>	Cubic metre

<b>in<sup>3</sup></b>	Cubic inch
<b>gal</b>	American gallon
<b>GAL</b>	British gallon
<b>ft<sup>3</sup></b>	Cubic foot
<b>Bbl</b>	Standard barrel
<b>BBL</b>	Oil barrel
<b>yd<sup>3</sup></b>	Cubic yard
<b>kgl</b>	KAmerican gallon
<b>KGL</b>	KBritish gallon

<b>Oz</b>	Ounce
<b>Lb</b>	Pound
<b>Ton</b>	short tons

<b>G</b>	Gram
<b>Kg</b>	Kilogram
<b>T</b>	Ton

When a mass unit of measure is set, the specific gravity function is automatically enabled by the system. Please, note that the temperature heavily affects the mass measure and therefore with certain liquids this may cause significant measure errors. The units of measure of time may be chosen among the following values: **s** = second, **m** = minute, **h** = hour, **d** = day.

**(POS. 2.3) Unit of measure and number of decimal totalizes** [UM.tot:dm<sup>3</sup>X.XXX]

Setting the unit of measure and number of decimals for visualized the totalizes or the volumes to batch. For set the unit of measure, position the cursor on field of the actual unit of measure; For set the type of unit, position the cursor on the blank space between the unit of measure and the numeric value; For set the number of decimal totalizes position the cursor on numeric field and choose one of the possible combinations: 1000-01.00-001.0-00001.

**\* (POS.2.4) Pulse value and unit of measure of tot.** [PLS= dm<sup>3</sup>X.XXXXX]

Setting of the pulse volume and of the totalizers measure units. There are three fields to fill in to set this parameter, from left to right: 1) measure unit, 2) unit type and 3) numeric value. The selection is performed by positioning the cursor on the field to be modified. To change the unit type (metric, British or American, mass or volume) just position the cursor on the blank space between the measure unit and the numeric value. When the nominal diameter is set to zero it is possible to modify only the numeric field since the measure unit stays at meter (m) or feet (ft). The possible measure units are those above described

**(POS.2.5) Pulse duration channel** [TPLS=msXXXX.XX]

Setting of the duration of the pulse generated. The possible values are : 16-31-63-125-250-500 mS and 1 or 2 second .

**ATTENTION:** since the instrument cannot detect which type of device it is connected to, it is up to the user to verify the set pulse duration is compatible with the external device processing such pulses. If, for example, an electro-mechanical pulse counter is connected, then two kind of problems may occur: if the pulse is too long than the coil may burn or, if it is too short, the counter may not be able to count and eventually even cause the damaging of the output itself.

### MENU 3.MEASURE

**(POS. 3.1) Time constant** [TCONST=s XXXX.X]

This parameter affects the integrating filter making the instrument response quicker or slower, according to the set value. A higher value corresponds to a more stable but slower measure, a smaller value the opposite. The most common values are from 1 to 5 seconds. The valid range of value it's from 0 (integral filter disabled) to 6000.0 seconds. The following diagram shows the response of the instrument for a flow rate variation from 0 to 100% within the T time constant period

**(POS. 3.2) Acceleration threshold** [SKIP THR=%XXX]

Acceleration threshold set. The acceleration threshold stands for the limit beyond which a flow rate variation determines an immediate response at the output, without being filtered by the time constant. This system allows the instrument to have an immediate response in case of big variations of the flow rate, filtering (and delaying) the response to small variations. The result of that is a very stable measure, ready to follow the process. The value is set as percentage of the full scale value from 0 to 125%. If such a value is set to zero any flow rate variation bigger than 0.5% of the full scale value will immediately affect the outputs. The following diagram shows the

instrument response in two cases: a flow rate variation from 0 to 10% completely absorbed by the time constant effect and a variation from 10% to 100% exceeding the acceleration threshold and then immediately sent to the output. In actual fact there is always a minimum time between the measure acquisition and the outputs update.

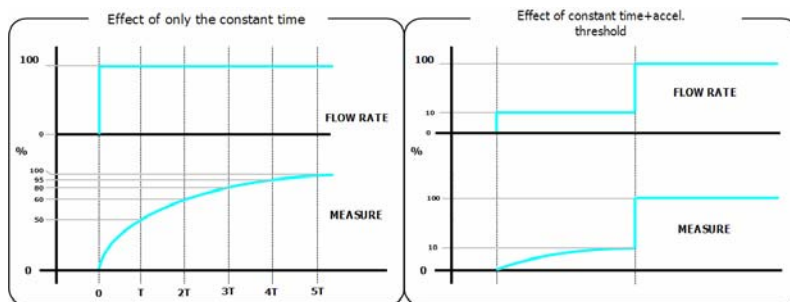

### (POS. 3.3) Peak cut off threshold

[PEAK THR=% XXX]

Anomalous signal pick cut off threshold set. This parameter allows setting the maximum value of deviation of the actual measure sample by comparison with the average one. If the new value is higher than the set limit, than such a value is "cut" to the limit value. This function is used to make the meter less sensitive to big perturbations on the flow rate measure, as it may happen when there are solids in suspension in the liquid hitting against the electrodes determining a high electrical noise. The permitted values of this function **range** from 0 to 125 % and are referred to the full scale value. If this parameter is set to zero the peak detection function is disabled and any new measure ample will be accepted and processed as it is by the converter.

## MENU 4.ALARMS

### (POS. 4.7) Current output value in case of failure

[mA VAL.FAULT =% XXX]

Setting of the value the 0/4...20 mA current output has to be in one of the following cases: empty pipe; coils interrupted; ADC error

**N.B.:** To set this parameter to zero corresponds to disable the alarm



## MENU 5.INPUTS

### (POS. 5.1-5.2-5.3-5.4) Modify/reset totalizer enable

[T/P+/-RESET=ON/OFF]

To make the reset of the totalizer from the key board it is necessary enable the functions from 5.1 to 5.4.

From visualisation pages, proceed in the following mode:

pushing the key  from visualization page, at the required "RESET TOTALIZ.?" Push the key  and then the key  to confirm or any other key to cancel this operation

### (POS.5.6)"Autozero"calibration external command enable

[CALIBRATION=ON/OFF]

When this function is active, applying a voltage on the on/off input terminals the meter performs a autozero calibration cycle. ATTENTION: if the voltage pulse is less 1 sec., the meter performs a calibration cycle for compensate possible thermal drifts. If the voltage pulse is more 1 sec, the meter performs a zero calibration of measure. This function enables/disables the automatic zero calibration system. To perform the sensor it is absolutely necessary the sensor is full of liquid and that the liquid is perfectly staying still. Even very small movement of the liquid may affect the result of this function, and, consequently, the accuracy of the system.

## MENU 6.OUTPUT

**(POS. 6.1) Function corresponding to on/off output****[OUT1=XXXXXX]**

Choice of the function corresponding to digital Output 1. The functions are listed in the table

## FUNCTION FOR OUTPUT

OFF: DISABLED  
 IMP+: PULSE ON CHANNEL 1 FOR POSITIVE FLOW RATE  
 IMP-: PULSE ON CHANNEL 1 FOR NEGATIVE FLOW RATE  
 IMP: PULSE ON CHANNEL 1 FOR POSITIVE AND NEGATIVE FLOW RATE  
 SIGN: FLOW DIRECTION OUTPUT (ENERGISED = -)  
 MAX AL+: MAX DIRECT FLOW RATE OUTPUT(ENERGISED = AL. OFF)  
 MAX AL-: MAX REVERSE FLOW RATE OUTPUT(ENERGISED = AL. OFF)  
 MAX AL: MAX DIRECT/REVERSE FLOW RATE OUTPUT(ENERGISED = AL. OFF)  
 MIN AL+: MIN DIRECT FLOW RATE OUTPUT(ENERGISED = AL. OFF)  
 MIN AL-: MIN REVERSE FLOW RATE OUTPUT(ENERGISED = AL. OFF)  
 MIN AL: MIN DIRECT/REVERSE FLOW RATE OUTPUT(ENERGISED = AL. OFF)  
 MAX+MIN±: MAX AND MIN FLOW RATE ALARM OUTPUT (ENERGISED = AL. OFF)  
 EMPTY PIPE: EMPTY PIPE ALARM OUTPUT (ENERGISED = FULL PIPE)  
 OVERFLOW.: OUT OF RANGE ALARM OUTPUT (ENERGISED = FLOW RATE OK)  
 HW ALARM: CUMULATIVE ALARM OUTPUT interrupt coils, empty pipe, measure error (ENERGISED = NO ALARMS)

**(POS. 6.3) Choice of the function and the range of current output****[OUT.mA1=X÷XX±]**Choice of the function and the range of current output N.1. The current output N.1 is **optional and it is mounted on the main board**. There are three fields to modify for this function:

- Scale zero: **4** ; Full scale: **20** or **22** mA
- Field: **+** = positive, **-** = negative, **±** = both, **-0+** = central zero scale

The values corresponding to the scale points are shown in the following chart:

POSSIBLE FIELD	CURRENT VALUES IN mA ASSOCIATE TO THE % VALUE OF FULL SCALE				
	REVERSE FLOW VALUE		ZERO	DIRECT FLOW VALUE	
	≤ -110%	-100%	0%	+100%	≥+110%
OutmA = 4 ÷ 20 +	4	4	4	20	20
* OutmA = 4 ÷ 22 +	4	4	4	20	22
OutmA = 4 ÷ 20 -	20	20	4	4	4
OutmA = 4 ÷ 22 -	22	20	4	4	4
OutmA = 4 ÷ 20 ±	20	20	4	20	20
OutmA = 4 ÷ 22 ±	22	20	4	20	22
** OutmA = 4 ÷ 20 -0+	4	4	12	20	20
OutmA = 4 ÷ 22 -0+	4	4.8	12.8	20.8	22



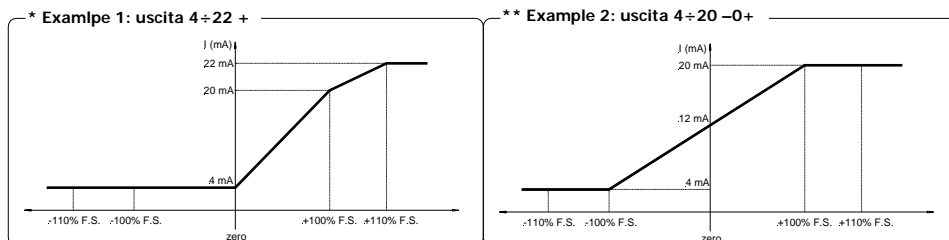

In hardware alarm conditions "HW ALARM" (interrupt coils, empty pipe, measure error) the current value is programmed by the function "mA VALL. FAULT" (pos. 4.7) and it is expressed as percentage of a fixed current range, where: 0% = 4 mA e 110% = 22 mA.



## MENU 8.DISPLAY

**(POS. 8.2-8.3-8.4-8.5) Reset totalizer****[T/P+/- RESET=ON/OFF]**

Reset of totalizer by key board;

**N.B.:** The reset of the totalizer may be done from the function listed upon pushing the key  and the key . The reset of partial totalizer /currency may be done also from the visualization pages at page 10 like this. Push the key  Set the L2 CODE if request and then push the key . At the question "RESET TOTALIZ.?" Push the key  to proceed with the zeroing. Push any other key to cancel this operation.

**(POS. 8.10-8.11) Conversion factor for flow rate totaliser****[EUR/dm<sup>3</sup>+ =X]**

Set the value of conversion/currency for direct totalise( positive ). There are three set fields for this parameter, from left to right: 1) monetary token, 2 ) default/personalized monetary token, 3 ) conversion coefficient. For the selection setting the cursor over the field to modify. The mode set of monetary token could be two:

- Choice of one of the 7 predetermined monetary tokens (standard ISO 4217-REV81):  
EUR = Eur ; USD = USA ; dollar CAD = Canadian dollar ; AUD = Australian dollar ; GBP = English pound ; CHF = Swissfranc ; JPY = Japanese yen.
- Choice three free characters (number or letter) . To change the characters , the cursor has to be positioned on the symbol "/" (field N. 2)

## MENU 10. DIAGNOSTIC



**(POS. 10.1) Meter "calibration"****[CALIBRATION]**

Enable the calibration of the meter. With this function the measure doesn't interrupted but start a cycle calibration of the input circuit of the converter.

The activation of this function happens pressing the key  during the visualization of the function.

Will be visualized the following question: " EXECUTE?" press the key  to proceed . Press any other key to delete the operation





**(POS. 10.2) "Autotest" function enable****[SELF TEST]**

Meter autotest function. This function stops the normal functions of the meter and performs a complete test cycle on the measure input circuits and on the excitation generator. To activate this function, after select it, push key , at the question: "EXECUTE?" push the key .

For start autotest, or any other key for delete operation. The result of the test is shown on the display. At the end of operation will have visualized one of visualization page. This function is automatically performed when switching on the device.

**(POS. 10.3) Flow rate simulation****[SIMULATION]**

Flow rate simulation enabling. With this function it is possible to generate an internal signal that simulates the flow rate, allowing the outputs and all the connected instruments test. After enabling it, the flow rate simulation can be:

- set: by pushing the key  from one of four visualization pages
- started: by pushing the key  after set it
- finished: by pushing the key  from visualization pages and then by pushing the key .

## Alarm messages, causes and actions to be taken

Messages	ANOMALIES	ACTION TO TAKE
<b>NO ALARMS</b>	All works regularly	-----
<b>MAX ALARM</b>	The flow rate is higher than the maximum threshold set	Check the maximum flow rate threshold set and the process conditions
<b>MIN ALARM</b>	The flow rate is lower than the minimum threshold set	Check the minimum flow rate threshold set and the process conditions
<b>FLOW RATE &gt; FS</b>	The flow rate is higher than the full scale value set on the instrument	Check the full scale value set on the instrument and the process conditions
<b>PULSE/FREQ&gt;FS</b>	The pulse generation output of the device is saturated and cannot generate the sufficient number of impulses	Set a bigger unit of volume or, if the connected counting device allows it, reduce the pulse duration value
<b>EMPTY PIPE</b>	The measuring pipe is empty or the detection system has not been properly calibrated	Check whether the pipe is empty or perform again the empty pipe calibration procedure
<b>INPUT NOISY</b>	The measure is strongly effected by external noise or the cable connected the converter to the sensor is broken	Check the status of the cables connecting the sensor, the grounding connections of the devices or the possible presence of noise sources
<b>EXCITATION FAIL</b>	The coils or the cable connecting the sensor are interrupted	Check the connecting cables to the sensor
<b>CURR. LOOP OPEN</b>	The 0/4...20mA output on board or the optional one are not correctly closed on a valid load	Verify the load is applied to the output (max 1000 ohm). To disable the alarm, set the "mA VAL.FAULT" value ( menu alarm ) to 0.
<b>P.SUPPLY FAIL</b>	Power supply different from that indicated on the label.	Verify that the power supply is that indicated on the label

## Anomalies codes

CODES	ANOMALIE DESCRIPTIONS	ACTION TO TAKE
0001	<b>problem with watch-dog circuit</b>	ADDRESSING TO SERVICE
0002	wrong configuration work data in eeprom	
0004	wrong configuration safety data in eeprom	
0008	defective eeprom	
0010	defective keyboard (one or more key are pushed during the test)	
0020	Power supply voltage (+3.3) is out of range	
0040	Power supply voltage (+13) is too low (<10V)	
0080	Power supply voltage (+13) it's too high (>14V)	
0200	timeout calibration input (input circuit is broken)	
0400	Gain input stage is out of range	
0800	Interruption on the coils circuit	Check the status of the cables connecting the sensor to the converter
0C00	Cumulative alarm 0800 + 0400	see single code

**DECLARATION OF CONFORMITY****Isoil Industria SpA**

it declares under the own responsibility that the product:

**ISOMAG** ™

Model converters

**ML51**

Model sensors

**MS 500 – MS 501 – MS 600 – MS 1000 – MS 2410- MS 2500 – MS 3700 MS 3770 – MS 5000**

to which this declaration refers, is in compliance with the following  
Harmonized European Norms:

- **CEI EN 61010-1(2001)**
- **CEI EN 61326-1 (2007)**

and therefore answering to essential requirement of CE directives:

- **2006/95/CE (Low voltage directive – LVD)**
- **2004/108/CE (Electromagnetic compatibilit  Directive – EMC)**

25/11/2007

  
THE LEGAL REPRESENTATIVE**ISOIL**   
INDUSTRIA

via f.lli Gracchi, 27 20099 Cinisello Balsamo (Mi)  
Tel. +39-02-660271- Fax +39-02-6123202



**FILE NAME:**  
**51\_EN\_IS\_1\_3\_0X.doc**

The last three character of file name , identify the sw version which the manual is refer . the sw version is visualized during switch on of converter

**ISOIL**   
INDUSTRIA

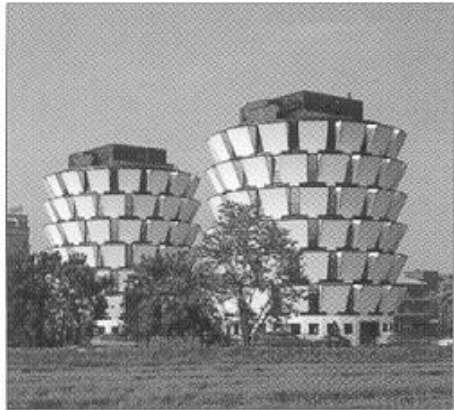

**Isoil Industria spa**  
Head office  
**20092 Cinisello Balsamo (MI) Italy**  
27, via F.lli Gracchi  
Phone +39/0266027.1  
Fax +39/026123202  
E-mail: sales@isoil.it  
Web: www.isoil.com

Stocks  
**35044 Montagnana (PD) Italy**  
21/A, via Frassenara

**24061 Albano S.Alessandro (BG) Italy**  
74, via Madonna delle Rose